

ŘADA-SERIES GAMMA

837600 GAMMA 62 TS 2C
837700 GAMMA 62 TS 1C
837800 GAMMA 62 TS GR

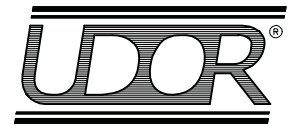

GAMMA 62 TS 2C

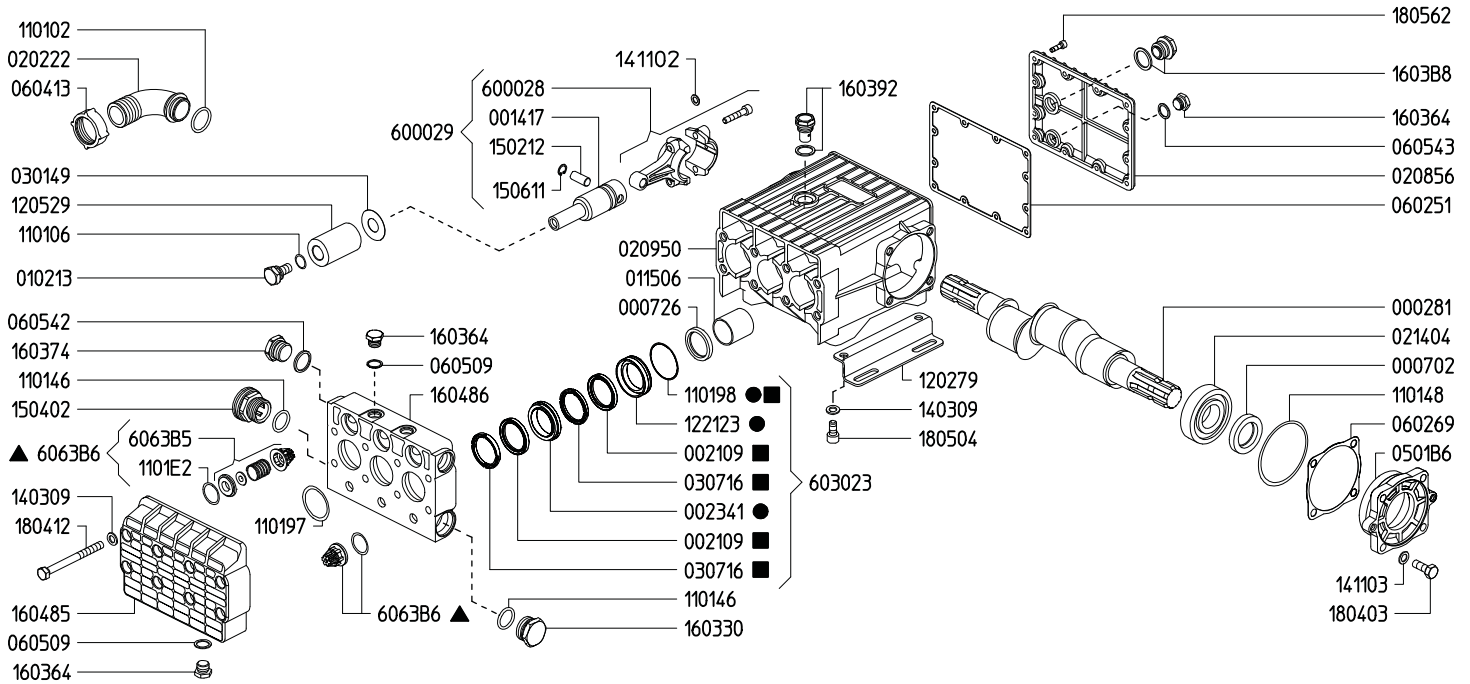

GAMMA 62 TS GR

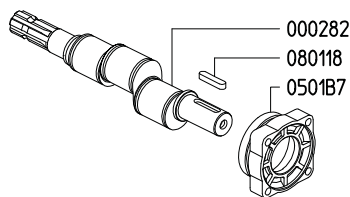

Rozdíly verze TS GR vůči verzi TS 2C
Variables of version TS GR compared to TS 2C

GAMMA 62 TS 1C

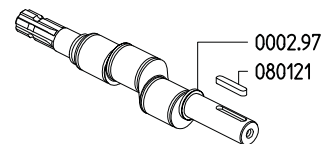

Rozdíly verze TS 1C vůči verzi TS 2C
Variables of version TS 1C compared to TS 2C

KIT 564		KIT 600		KIT 602	
606265		6062A1		6062A3	
▲		■		●	
KÓD CODE	KS QTY	KÓD CODE	KS QTY	KÓD CODE	KS QTY
6063B6	6	002109	6	002341	3
		030716	6	110198	3
		110198	6	122123	3

ŘADA-SERIES GAMMA

838100 GAMMA 80 TS 2C
838600 GAMMA 100 TS 2C
839100 GAMMA 122 TS 2C

838200 GAMMA 80 TS 1C
838700 GAMMA 100 TS 1C
839200 GAMMA 122 TS 1C

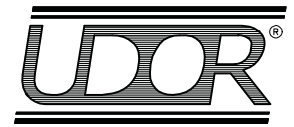

GAMMA 80 TS 2C

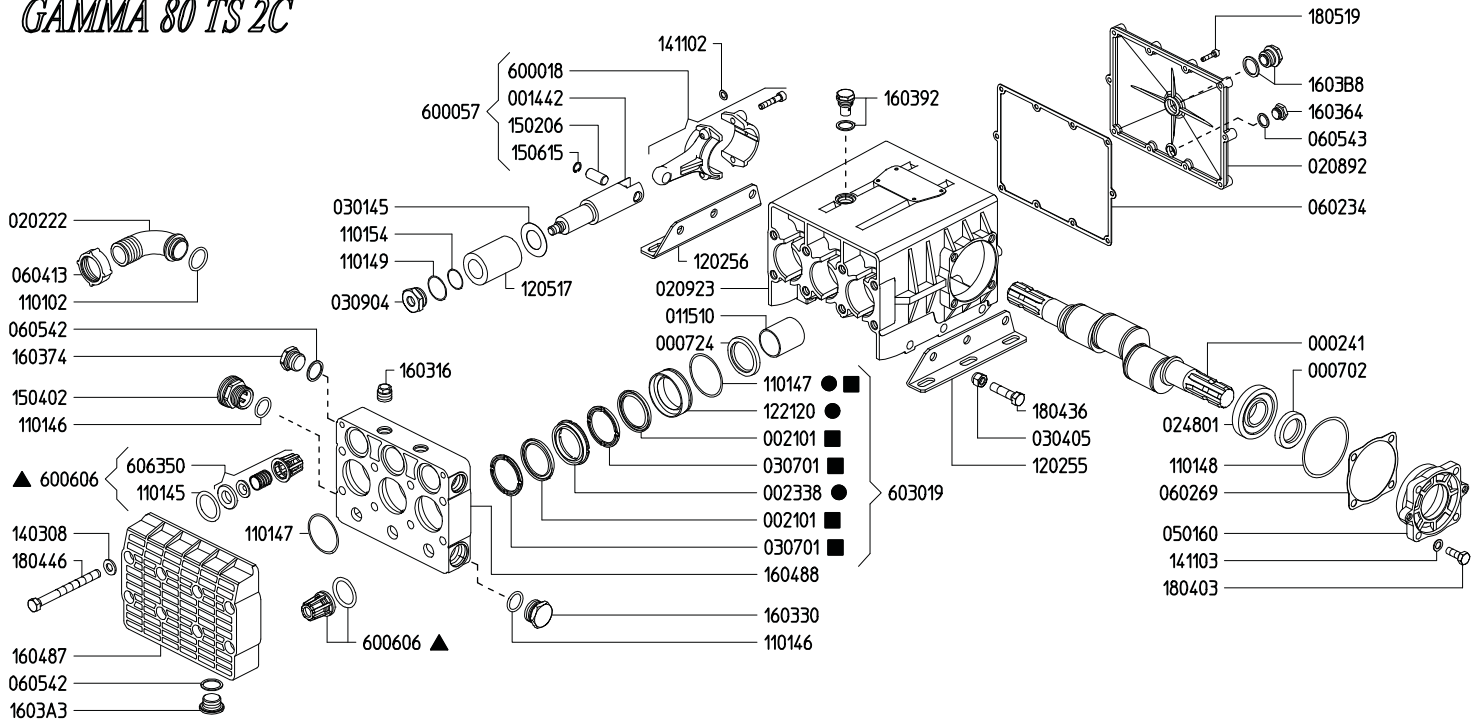

GAMMA 80 TS 1C

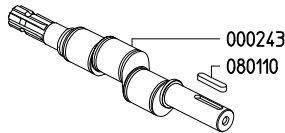

Rozdíly verze TS 1C vůči verzi TS 2C
Variables of version TS 1C compared to TS 2C

GAMMA 122 TS 2C

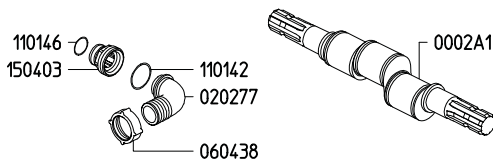

Rozdíly modelu GAMMA 122 TS 2C vůči modelu GAMMA 80 TS 2C
Variables of version GAMMA 122 TS 2C compared to GAMMA 80 TS 2C

GAMMA 122 TS 1C

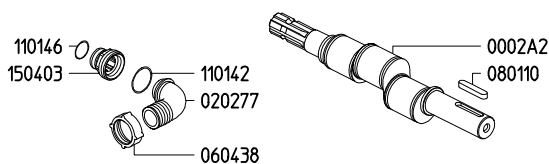

Rozdíly modelu GAMMA 122 TS 1C vůči modelu GAMMA 80 TS 2C
Variables of version GAMMA 122 TS 1C compared to GAMMA 80 TS 2C

GAMMA 100 TS 2C

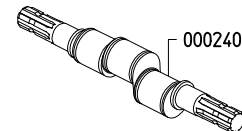

Rozdíly modelu GAMMA 100 TS 2C vůči modelu GAMMA 80 TS 2C
Variables of GAMMA 100 TS 2C compared to GAMMA 80 TS 2C

GAMMA 100 TS 1C

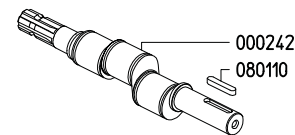

Rozdíly modelu GAMMA 100 TS 1C vůči modelu GAMMA 80 TS 2C
Variables of version GAMMA 100 TS 1C compared to GAMMA 80 TS 2C

KIT 548		KIT 549		KIT 550	
606249		606250		606251	
▲		■		●	
KÓD CODE	KS QTY	KÓD CODE	KS QTY	KÓD CODE	KS QTY
600606	6	002101	6	002338	3
		030701	6	110147	3
		110147	6	122120	3

ŘADA-SERIES GAMMA

839600 GAMMA 162 TS 2C
837100 GAMMA 202 TS 2C
840100 GAMMA 242 TS 2C

839700 GAMMA 162 TS 1C
837200 GAMMA 202 TS 1C
840200 GAMMA 242 TS 1C

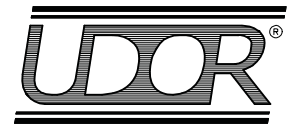

GAMMA 162 TS 2C

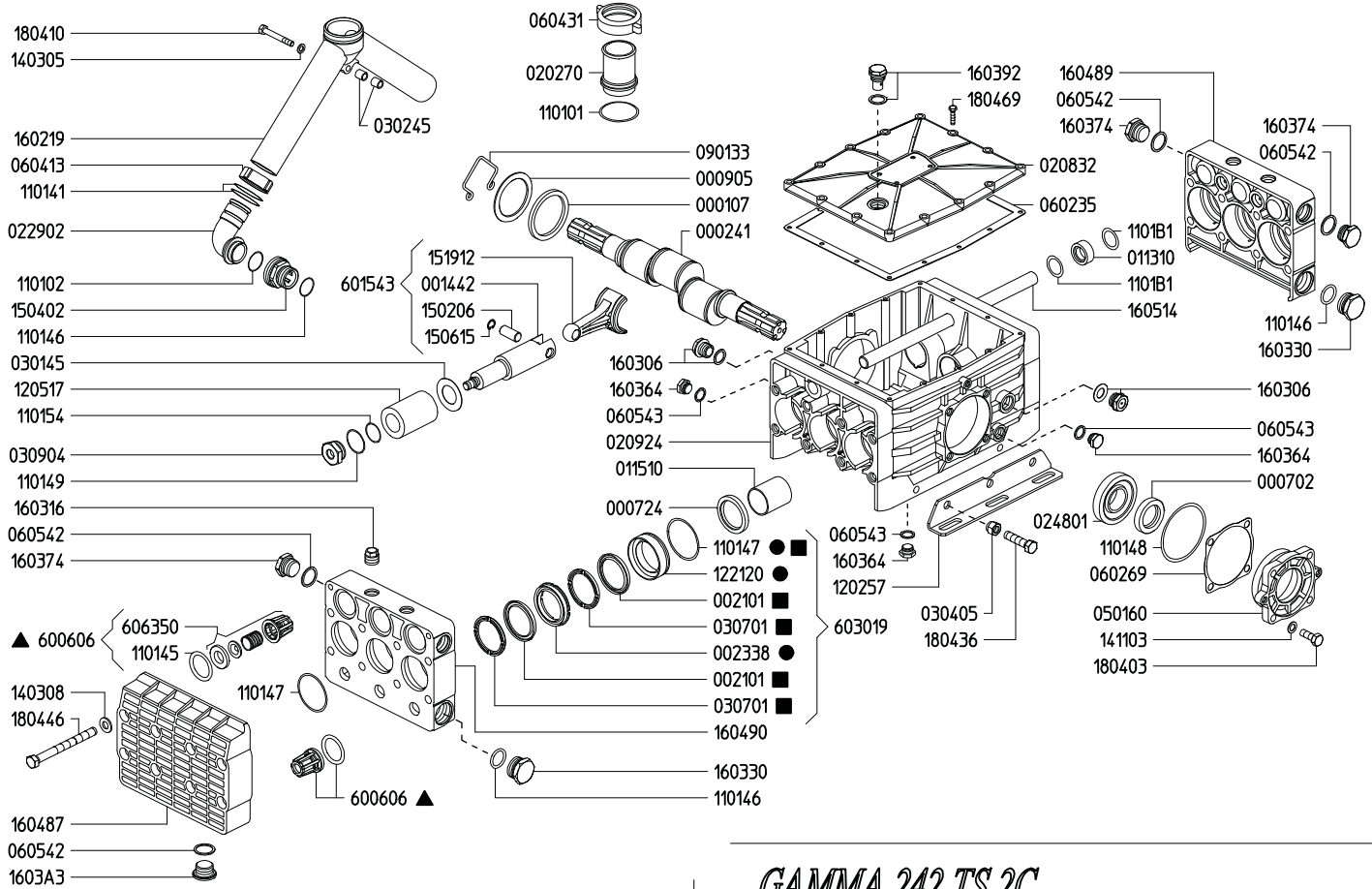

GAMMA 162 TS 1C

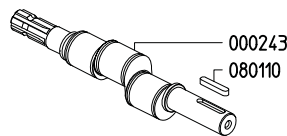

Rozdíly verze TS 1C vůči verzi TS 2C
Variables of version TS 1C compared to TS 2C

GAMMA 202 TS 2C

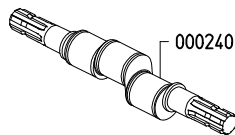

Rozdíly modelu GAMMA 202 TS 2C vůči modelu GAMMA 162 TS 2C
Variables of version GAMMA 202 TS 2C compared to GAMMA 162 TS 2C

GAMMA 202 TS 1C

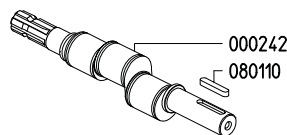

Rozdíly modelu GAMMA 202 TS 1C vůči modelu GAMMA 162 TS 2C
Variables of version GAMMA 202 TS 1C compared to GAMMA 162 TS 2C

GAMMA 242 TS 2C

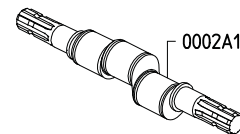

Rozdíly modelu GAMMA 242 TS 2C vůči modelu GAMMA 162 TS 2C
Variables of GAMMA 242 TS 2C compared to GAMMA 162 TS 2C

GAMMA 242 TS 1C

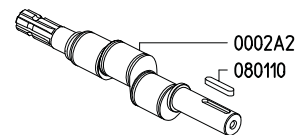

Rozdíly modelu GAMMA 242 TS 1C vůči modelu GAMMA 162 TS 2C
Variables of version GAMMA 242 TS 1C compared to GAMMA 162 TS 2C

KIT 569		KIT 570		KIT 571	
606270		606271		606272	
▲		■		●	
KÓD CODE	KS QTY	KÓD CODE	KS QTY	KÓD CODE	KS QTY
600606	12	002101	12	002338	6
		030701	12	110147	6
		110147	6	122120	6