

**ZETA 100** max. 98 l/min - 25.9 GPM • 20 bar - 290 PSI • 550 RPM

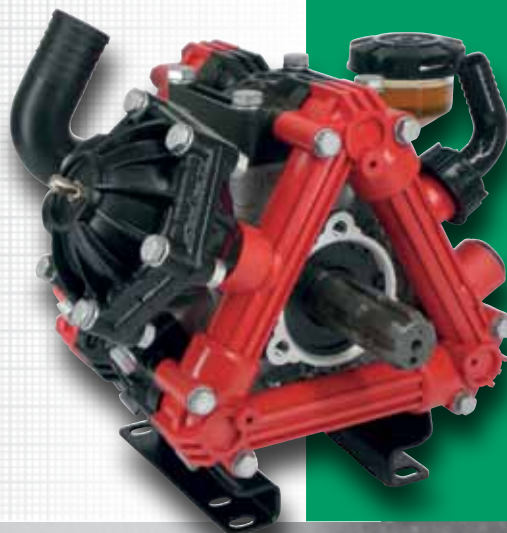

provedení P.T.O. hřídele available P.T.O. shaft

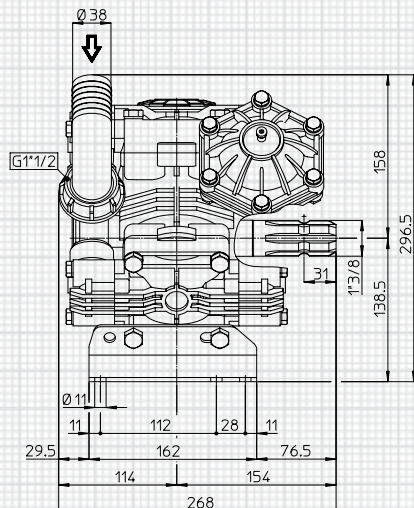
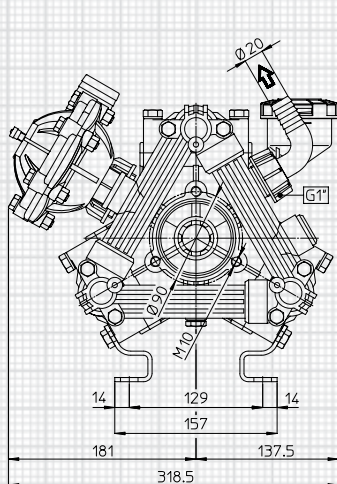

2-13

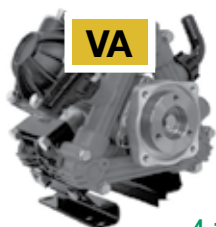

4-15



1

2-13

Rozměry P.T.O.  
viz strana 8

For P.T.O.  
shaft dimensions  
see page 8

příslušenství k hřídelům shaft adaptors

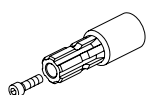

1

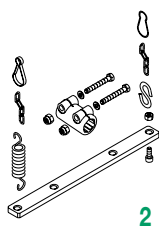

2

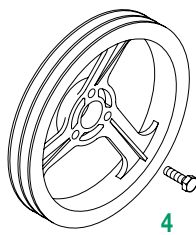

4



13

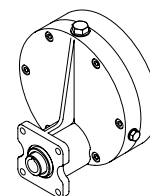

Převodovky **15**  
viz strana 43

Gear reduction **15**  
See page 43

MOD.	RPM	0 bar / 0 PSI				5 bar / 72 PSI				10 bar / 145 PSI				15 bar / 217 PSI				20 bar / 290 PSI				Hmotnost Weight	
		Průtok Flow rate		Výkon Power		Průtok Flow rate		Výkon Power		Průtok Flow rate		Výkon Power		Průtok Flow rate		Výkon Power		Průtok Flow rate		Výkon Power			
ZETA 100		l/min	GPM	HP	kW	l/min	GPM	HP	kW	l/min	GPM	HP	kW	l/min	GPM	HP	kW	l/min	GPM	HP	kW	13	28,7
	400	72,8	19,2	0,7	0,5	69,2	18,3	1,4	1,0	68,8	18,2	2,0	1,4	68,4	18,1	2,7	2,0	68,2	18,0	3,6	2,6		
	450	81,6	21,6	0,8	0,6	77,6	20,5	1,6	1,1	77,2	20,4	2,2	1,6	75,5	19,9	3,0	2,2	76,4	20,2	4,0	3,0		
	500	90,4	23,9	0,9	0,7	86,0	22,7	1,7	1,3	85,6	22,6	2,4	1,8	82,5	21,8	3,3	2,4	84,6	22,4	4,5	3,3		
550	98,0	25,9	1,0	0,7	92,7	24,5	1,9	1,4	92,2	24,4	2,6	1,9	91,7	24,2	3,7	2,7	91,3	24,1	4,8	3,5			