

**1C**

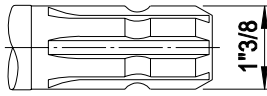

**VA**

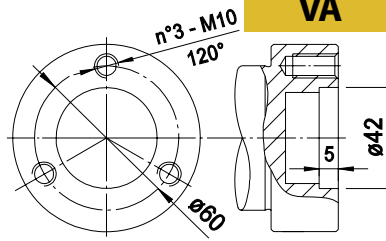

**GR**

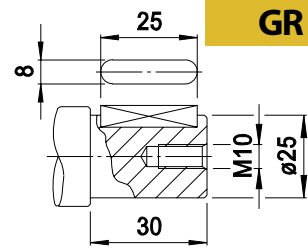

**TS2C**

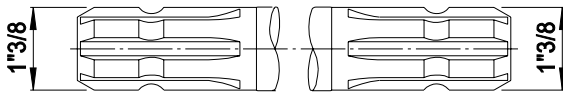

**TS MF**

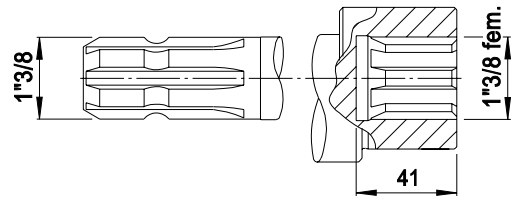

**TS FVA**

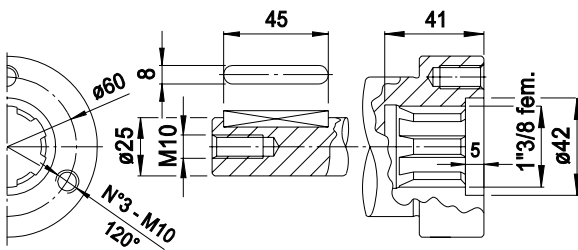

**TS GR**

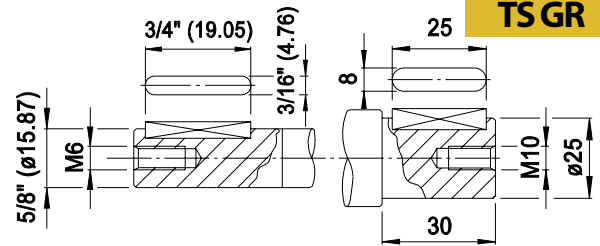

**TSVA**

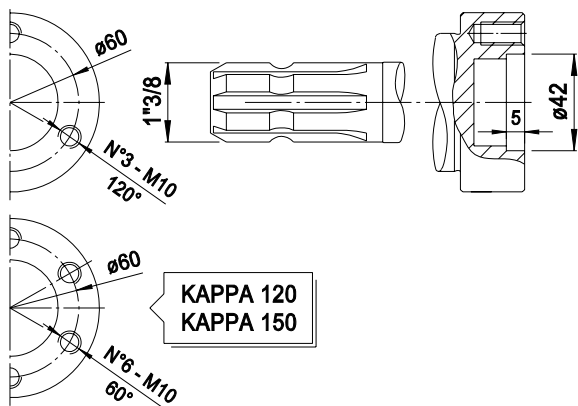

**TS 1C**

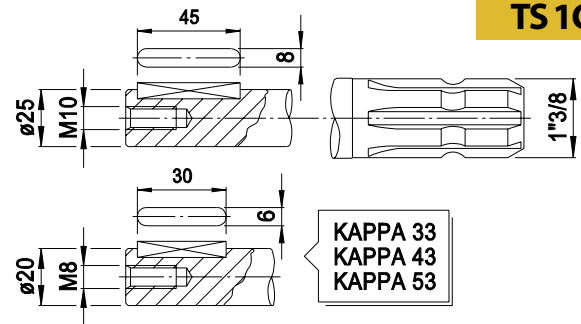

**MI**

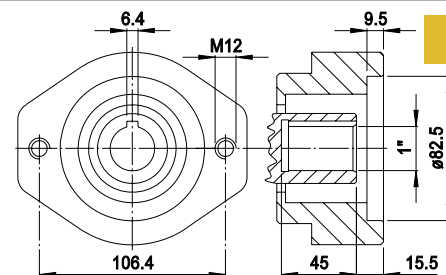

KAPPA 120  
KAPPA 150

KAPPA 33  
KAPPA 43  
KAPPA 53